



# مشاريع البرهان الجديدة ش.م.م. New Burhan Enterprises LLC



00968-94264312,  
00968-99252583

*email*

*New Burhan Enterprises is a facility maintenance and services providing company built with a vast experience. We can provide all types of maintenance services and programs related to any work. We are able to maintain all building services equipment, whether it is commercial, residential and industrial work, utilizing either our directly employed labour force, or special sub-contractors, who meets our requirement both in terms of quality assurance and health and safety. New Burhan will provide a quality services at the competitive prices, together with the recognition of client's requirements and provision for cost effective solutions and high-level services delivery.*

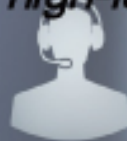

*Adress*



## Our Policies

### Annual Contract



*It is a benefit for the client as it helps to avoid high repair cost and costs for unexpected damages. It includes regular checkups of networks and spare parts could be if needed. Continuous upgrades/updates are completed and its keep company on compliance with their standards.*

*New Burhan is just a call away to provide any type of A.M.C contracts and any types of services in water filtration plants ,air conditioning or any types of renovation work. Operations and maintenance only,any types of parts replacement will cost extra. Our operation and maintenance include services like R. o. membrane cleaning, engineering services, replacement of any types of parts.*

### Ideology



### Strenght



*We have a team of experienced and professional experts who have over 15 years of experience in the field of environmental engineering,planning and execution. We have panels of experts comprising engineers and technicians. We assigned an expert technician as well as engineer for each project ensuring responsive communication and accountability to our customers throughout.*

*New Burhan is just a call away to provide any type of A.M.C contracts and any types of services in water filtration plants, air conditioning or any types of renovation work. Operations and maintenance only,any types of parts replacement will cost extra. Our operation and maintenance include services like R. o. membrane cleaning,engineering services, replacement of any types of parts.*

### Benefits





مشاريح البرهان الجديدة ش.م.م

New Burhan Enterprises LLC

MANAGEMENT

# Our Services

Water Filtration Plants



Waste Water Treatment



Man Power Supply



Pest Control



Solar EPC Integration





مشاريع البرهان الجديدة ش.م.م

New Burhan Enterprises LLC

**Supply of Equipments and  
spare partsof Filtration Plants**



**Maintenance and Services of  
Window A.C and H.V.A.C**



**All Types of Renovation  
Work**



**Upgrading of Existing  
Filtration Plants**



**Cleaning Services**





# مشاريح البرهان الجديدة ش.م.م. New Burhan Enterprises LLC

## Waste Water Treatment

### Goals of water treatment:

- 1-To protect the health community. (portability or primary drinking water standards.
- 2-To supply water that is aesthetically desirable. (portability or secondary drinking water standards.
- 3-To protect the property of the consumers.
- 4-All the above criteria should be achieved at the reasonable cost.

Removing the coarse suspended and floating matters such as rags, plastic, pieces of woods, etc.; by means of screening. Remove grit, sand, broken glass, etc. in grit chambers. Remove oily substances by floating it in the skimming tank.

## WASTE WATER TREATMENT PROCESS

An overview of how waste water is cleaned and treated before returning to the water supply.

(Methods vary between countries depending on water standards)

36% of the World's population does not have adequate sanitation.

Source - World Health Organisation



### 1

Waste water and sewage is pumped underground to the lifting station where it is chemically treated and sent for separation.

### 2

The separation process filters out solids larger than 1.3mm. This waste is then transported to a refuse facility and buried.

### 3

Primary settling basins allow heavier material to sink and be scraped away. The waste is then fermented for 30 days and used as fertilizer.

### 4

Aerated effluent is then pumped to the bio-reactors for 9 hours. Through a series of stages bacteria break down harmful matter and clean the water.

### 5

Secondary Clarifiers gravity feed the water through and bacteria continues to clean the water to a drinkable level.

### 6

The water is finally chemically treated with chlorine to ensure it is free from bacteria. Then it passes over a weir and into the water supply.

WWW.GRAHAMSCUTT.CO.UK

GRAHAM SCUTT © 2012

**B.O.D. test determine the amount of oxygen required to oxidize the organic matter in the waste water. It determines the size of treatment system needed. It assesses the efficiency of treatment process.**



# مشاريح البرهان الجديدة ش.م.م New Burhan Enterprises LLC

## Waste Water Management

*Start up services often required equipment maintenance, performance check, testing water quality etc. Repair service will help to diagnose and then provide the complete repair solution need.*

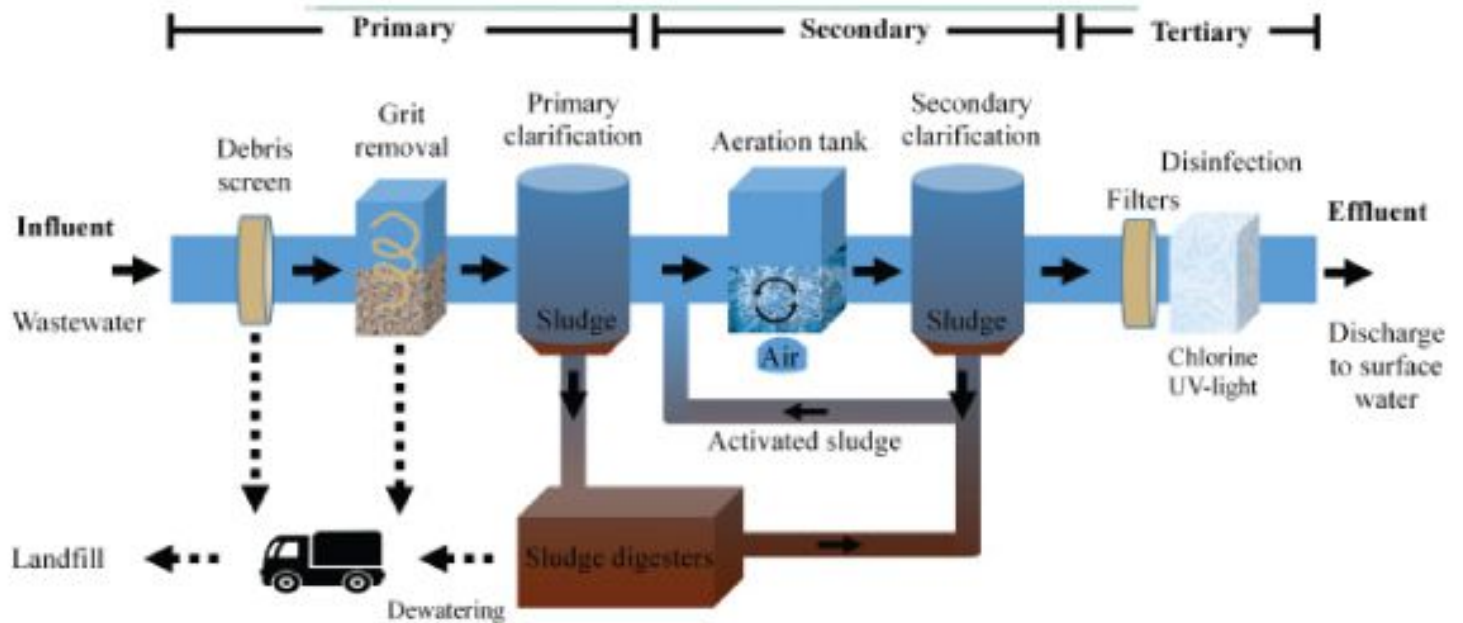

*Our preventive maintenance service typically include replacements of filters cartridges, ultra violet bulbs, filtration media Ph, chlorination Hardness, conductivity, R.O. parameters, calibration, mechanical checks on all equipment's and components.*





## Water Filtration Process

*Filtration are primarily used to remove particulate matter and turbidity from the water. The primary types of filters used in water treatment are rapid sand filter or gravity filter and pressure filters. Special membrane filters are used for particulate and microbial removal. Special filters are used to employ resin and media to remove contaminants such as iron and manganese. Activated carbon filters are used to remove organic compounds.*

### Water Source

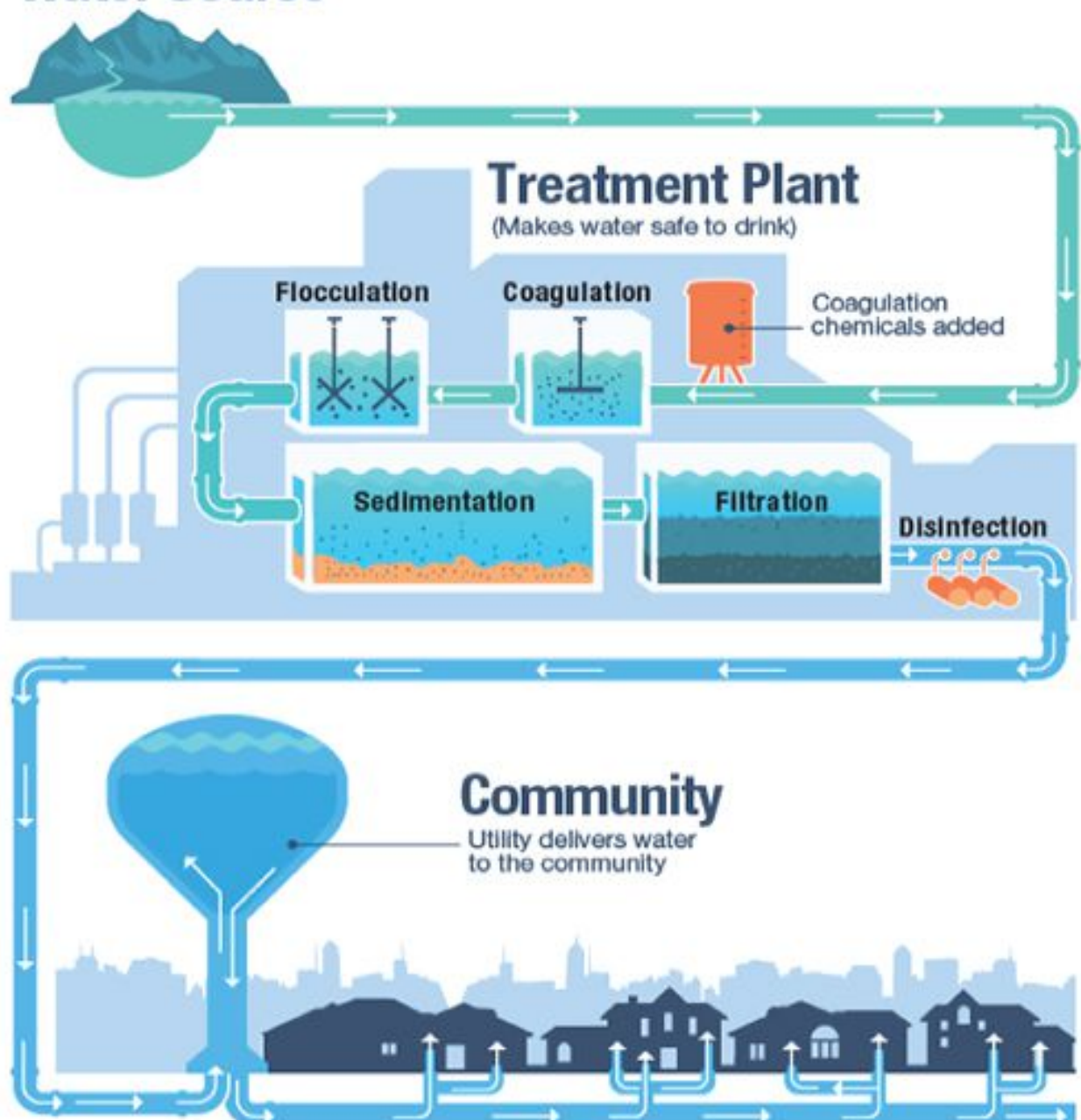



## Goals of Water Treatment



1-To protect the health community. (portability or primary drinking water standards.)

2-To supply water that is aesthetically desirable. (portability or secondary drinking water standards.)

3-To protect the property of the consumers.

4-All the above criteria should be achieved at the reasonable cost.

1-To protect the health community. (portability or primary drinking water standards.)

2-To supply water that is aesthetically desirable. (portability or secondary drinking water standards.)

3-To protect the property of the consumers.

4-All the above criteria should be achieved at the reasonable cost.

3 REASONS  
TO FILTER  
YOUR WATER

HARDNESS

SAFETY

TASTE







مشاريح البرهان الجديدة ش.م.م.  
New Burhan Enterprises LLC

## Annual Maintenance and Contract

Start up services often required equipment maintenance, performance check, testing water quality, etc. Repair service will help to diagnose and then provide the complete repair solution need. Our preventive maintenance service typically include replacements of filters cartridges, ultra violet bulbs, filtration media, chlorination. Hardness, conductivity, R.O. parameters, calibration, mechanical checks on all equipment's and components.





مشاريح البرهان الجديدة ش.م.م.  
New Burhan Enterprises LLC

## Specialized Cleaning Activities

### General Pest Control

Our service is family friendly and easy to work into your routine. After completing an initial flush out visit, we return regularly, usually just once per season, to attack pests where they nest and hide, as well as to put up protective barriers that prevent re-entry of pests into your home. Unlike many other services in the Pakistan area, the majority of our customers only see us once a season. Our goal is to do it right each time and to set a service schedule that works best with your home and situation.





مشاريح البرهان الجديدة ش.م.م.  
New Burhan Enterprises LLC

## Specialized Cleaning Activities

### House Keeping Services

Cleaning a house is no easy feat. To maintain the condition of the house, you need constant upkeep and we don't mean sweeping the floor and wiping furniture surfaces, but deep cleaning every corner of the house so that they're free from dust and grime.



### Hospitality Services

Hospitality Services provides productivity based value proposition with comprehensive Hospitality Management Services to our wide range of clients in Retail, Manufacturing, Corporate Offices & Residential with core specialization in Hospitality & Facility Management.





مشاريح البرهان الجديدة ش.م.م  
New Burhan Enterprises LLC

## General Maintenance





مشاريح البرهان الجديدة ش.م.م  
New Burhan Enterprises LLC

## Civil Renovation Work

Civil Renovation involves Masonry, Tiles Laying, Floor Renovation, Wall Construction, Structural Changes, Plumbing Line Renovation, Balcony Extension, Room Extension, Kitchen Extension, Improving Aesthetics, Painting, Electrical Renovation, Wall Cutting and other micro renovation.

Civil Renovation made easy. From Demolition to Remodeling, Every Work is taken care of by us. We provide Hassle-Free Civil Renovation, Bathroom Renovation & Remodeling Structural Renovation, Interior Renovation, Restyling and Redesigning Services.

No Running after different contractors for getting complete renovation done. All you have to do is contact us for End to End Civil Renovation Works.





# مشاريح البرهان الجديدة ش.م.م

## New Burhan Enterprises LLC

### HVAC and AC Maintenance

#### Experience

We have been providing all types of cleaning & repairing & self-care services for many years and expertise to resolve all your problems.

#### Quality

We use only the best equipment and cleaning products to ensure that your home and office are left looking fresh and clean.

#### Professionalism

Our team is composed of highly trained and experienced technicians who are committed to providing the highest level of service.

#### Flexibility

We offer flexible scheduling options to accommodate your busy schedule and can work around your availability.

#### Affordable

We offer competitive pricing for our services and are committed to providing value for money.

#### Satisfaction

Our team will work with you to ensure that you are completely satisfied with the results of our services.

#### Wide coverage

We serve a wide range of areas, so whether you are in the city or the countryside, we can come to you.

#### Variety of services

We offer a variety of services to suit your needs, whether you need a one-time clean, regular maintenance, or self-care services.

#### Professional Touch

We have a professional touch in all our services, you can trust that our team will approach your project with devotion to detail.

 <p>Know how AC works</p>	 <p>When &amp; Why you need AC maintenance</p>
 <p>Power off the AC When needed</p>	 <p>Clean &amp; Level Outdoor AC Condenser</p>
 <p>Clean the clogged Evaporator coil</p>	 <p>Change Blower filter</p>
 <p>Use programmable Thermostats</p>	 <p>Call HVAC Specialists</p>



00968-94264312,  
00968-99252583

email

Adress



مشاريح البرهان الجديدة ش.م.م  
New Burhan Enterprises LLC

# Sur Solar project - 17MW

A Renewal Energy Sustainability Supporting Company

00968-94264312,  
00968-99252583

email

## Solar EPC Integration & Skilled Man Power Supplier

A solar company that provides Engineering, Procurement, and Construction of a full solar system. An EPC company provides a full-service experience to seamlessly acquire a solar installation and receive continual support in maintaining the system.

### AREAS OF APPLICATIONS

Solar EPC intergration





مشاريح البرهان الجديدة ش.م.م  
New Burhan Enterprises LLC

New Burhan LLC is one of the most innovative solar companies. As a leading provider of solar solutions, it provides round-the-clock customer service with high-quality diversified solar systems.

It is more sophisticated in the services and products which provides compared to a typical solar installer. It takes a holistic approach to provide a solar service for their customers.

It is more sophisticated in the services and products which provides compared to a typical solar installer. It takes a holistic approach to provide a solar service for their customers.

## Sur Solar System -- 17 MW





مشروع البرهان الجديدة ش.م.م

New Burhan Enterprises LLC

Few Glimpse of Our Latest Solar EPC Interation





# مشاريح البرهان الجديدة ش.م.م New Burhan Enterprises LLC

You Can Avail Our Solar Energy Services  
For Multiple Utility Configurations.

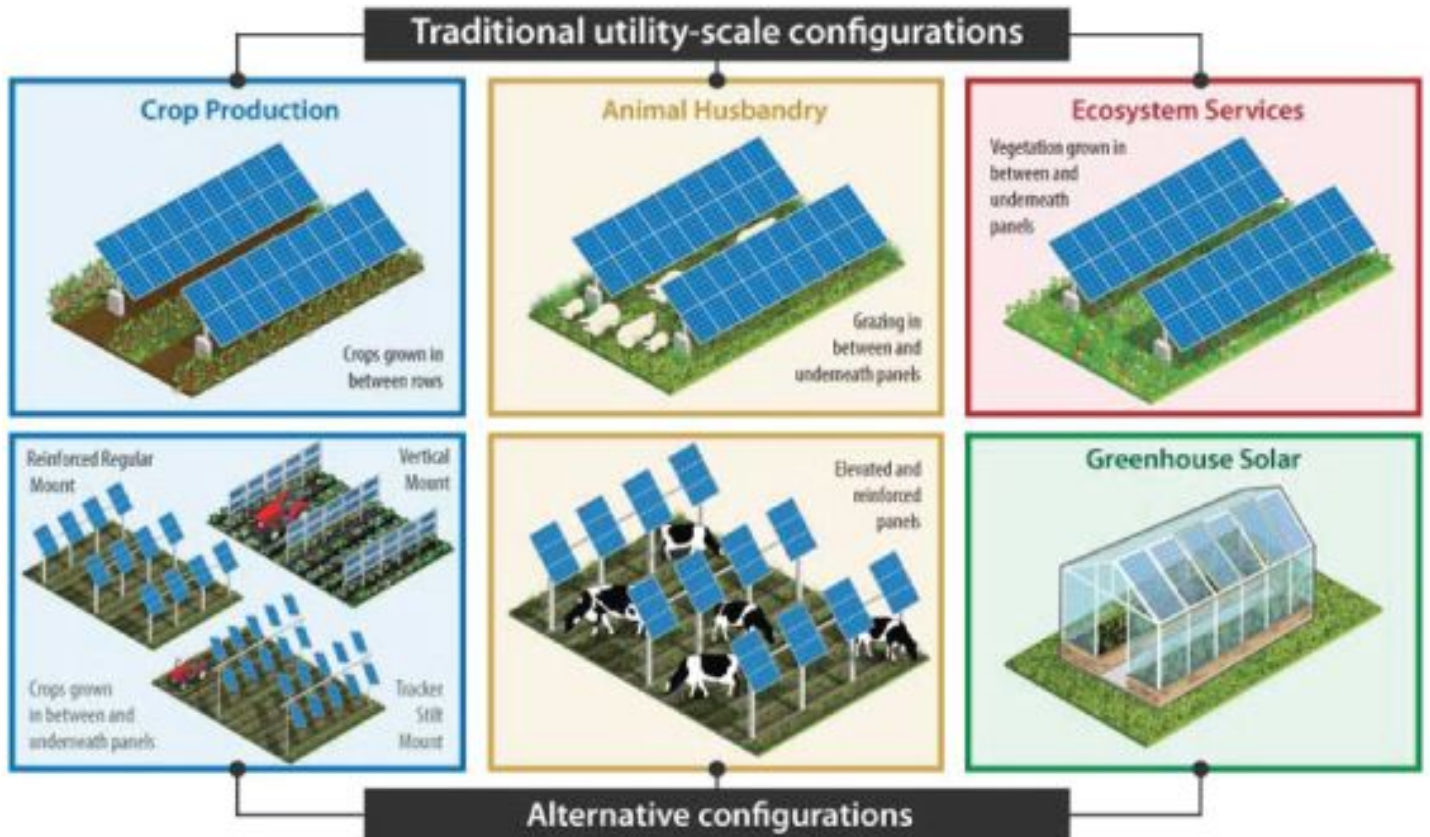

## HOW DOES COMMUNITY SOLAR WORK?



### SOURCE

We finance, construct and maintain a community solar garden offsite.

### DELIVERY

The energy is delivered to your local utility company for distribution.

### CUSTOMER

You save on your electric bill using green, sustainable energy.



# مشاريح البرهان الجديدة ش.م.م New Burhan Enterprises LLC



The grid-connected systems we will be examining here are of two types, although others exist. These are:

- Grid-connected AC system with no battery or generator back-up.
- Grid-connected AC system with battery back-up.

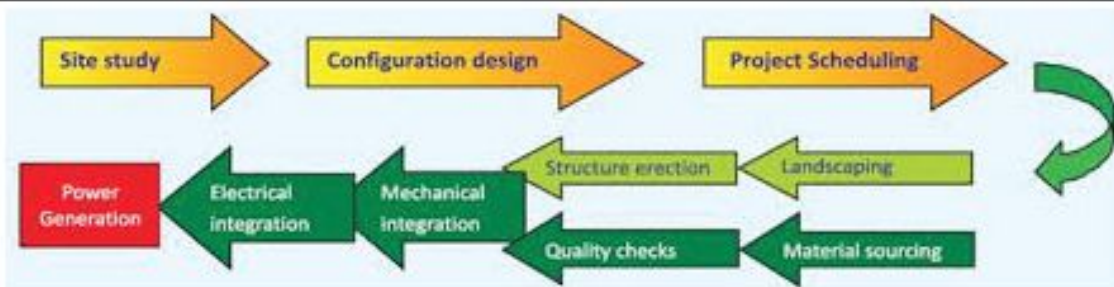
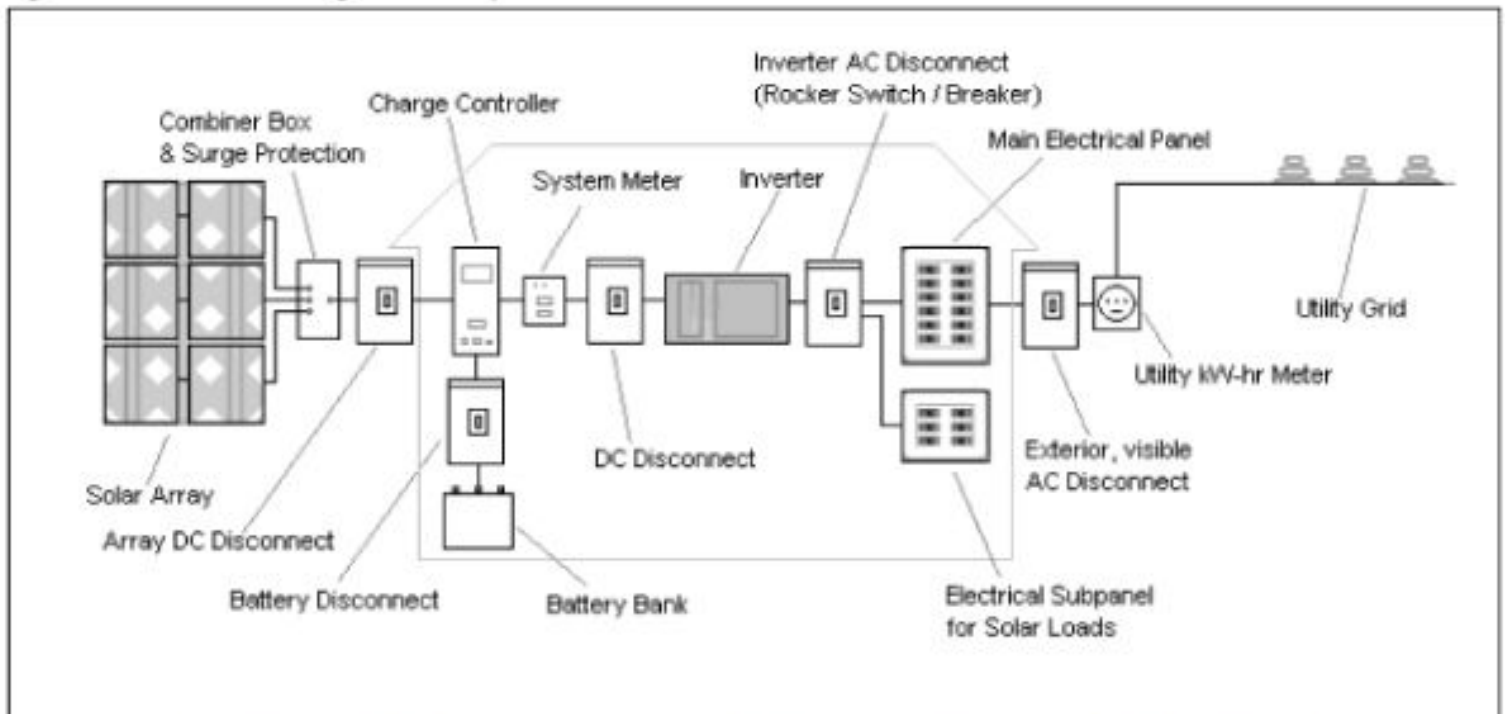



مشاريع البرهان الجديدة ش.م.م.  
New Burhan Enterprises LLC

**New Burhan Enterprises** LLC offers profitability, less worries, guarantee of excellent results.

### Perks of OUR Solar Integration

**New Burhan LLC** EPC contracts tend to coincide in many aspects, although they vary according to the needs of each project and are adapted to what both parts agree on. Broadly speaking, these are the tasks that usually regulate this type of agreement:

Basic and detailed engineering.

- The processing of some of the necessary permits to undertake the work, as well as for the commissioning of the installation.
- The procurement or supply, if the EPC company is also a manufacturer, of the materials and machinery necessary to undertake the project.
  - The transport of these materials to the plant.
  - The execution of civil works and mechanical assemblies and electrical and communication installations as required.
  - The commissioning of the installation.
  - The O&M tasks of the plant at least during the warranty period, which usually ranges from 1 to 3 years.



مشاريع البرهان الجديدة ش.م.م.  
New Burhan Enterprises LLC

## New Burhan LLC EPC Contractors

We have experienced, customer centered and professional team of contractors who are; **Experience in the sector.** It must be a company that knows the market fluctuations, the possible strategic allies, and the latest technological advances.

**Qualified professionals.** It is not only necessary that it has the best team of workers, but also that it has the tools and resources to train local workers. In addition, it is important that, due to their experience, they are familiar with the labor regulations of the area in which they operate.

**Seriousness and reliability.** The work of a good EPC company is backed by success stories and the favorable opinion of previous clients.

**Integration of all services** as far as possible. It is not always easy, but if there is the possibility of contracting a company with its own production capacity, this will facilitate supply and compliance with deadlines, even in times of volatility in the sector.

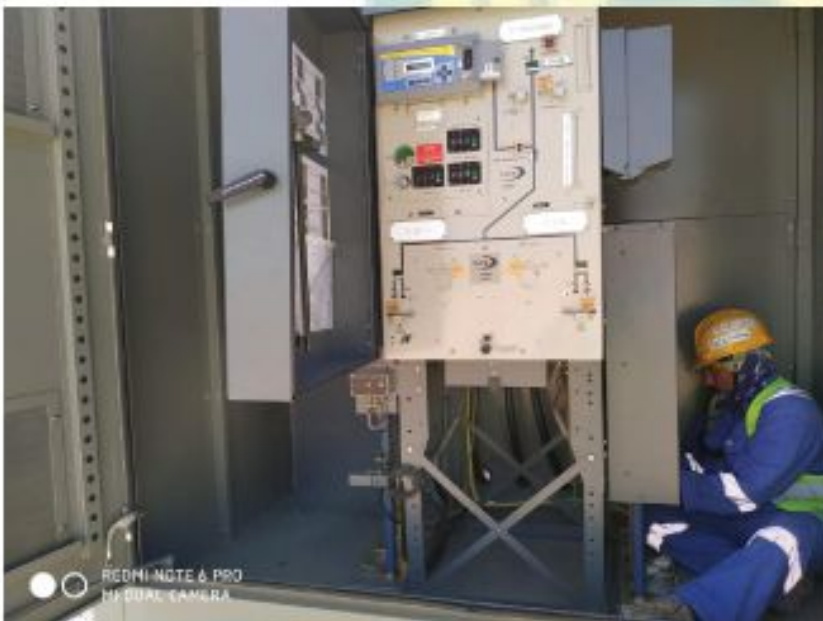



### How Solar Integration System Works

Solar energy is a rapidly growing industry, with an increasing number of homes and businesses adopting solar panel systems as a sustainable and cost-effective energy source. However, installing and maintaining these systems can be complex and challenging, requiring careful planning, coordination, and attention to detail.

This is where **New Burhan Enterprises LLC** comes in.

This information can then be used to determine the optimal location for the solar panels and ensure that they are installed in the most effective way possible.

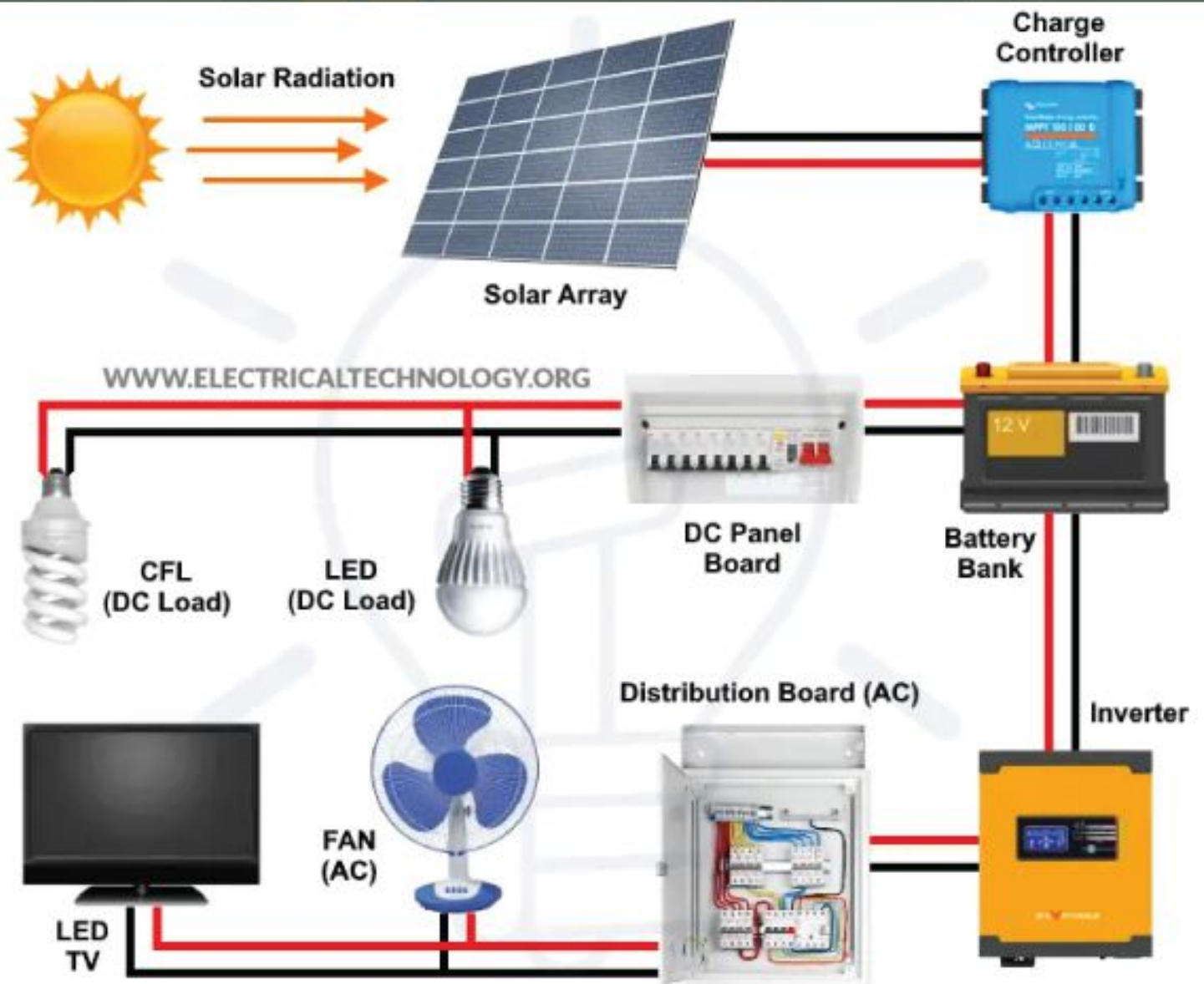



# مشاريح البرهان الجديدة ش.م.م New Burhan Enterprises LLC

## Solar System Commissioning

Solar commissioning is the process of configuring and verifying that all the PV components in each project are properly designed, installed, and optimized per the expected performance requirements of the solar system owner (or investor).

**New Burhan Enterprises LLC.** has developed an efficient system to perform commissioning testing with maximum efficacy. It involves;

1. **Electrical Testing**
2. **Mechanical Testing**
3. **Performance Evaluations**
4. **Corrections Reporting**





# مشاريع البرهان الجديدة ش.م.م New Burhan Enterprises LLC

## Benefits of Commissioning After Installation

**New Burhan LLC** Commissioning Process allows to;

- A.** Verify that all PV components are installed per manufacturer guidelines.
- B.** Ensure that the PV system has been installed per all engineering and design requirements.
- C.** Identify and correct any potential defects, energy losses, or performance issues within the solar project.
- D.** Enhance the financial security and ROI predictability of the entire clean energy investment.



Engineering Procurement  
& Construction (EPC)



Commissioning process



Operations & Management  
(O&M)







مشاريع البرهان الجديدة ش.م.م  
New Burhan Enterprises LLC

# THANK YOU



00968-94264312,  
00968-99252583

email

Adress